

NOZZLE SCHEDULE

ITEM	SIZE	RATING	TYPE	MATL	PROJ. IN	PROJ. OUT	REMARKS	NOTES
A	20"	U.L.	MANWAY	C.S.	STD.	STD.	SINGLE PUNCHED	TIGHT BOLTED
B	8"	N.P.T.	H. CPL.	C.S.	STD.	STD.	PRIMARY	EMERGENCY VENT OPENING
C	8"	N.P.T.	H. CPL.	C.S.	STD.	STD.	SECONDARY	EMERGENCY VENT OPENING
D	2"	N.P.T.	M.F.	C.S.	STD.	STD.	-	MONITORING PORT
E	4"	N.P.T.	W.F.	C.S.	STD.	STD.	-	-
F	2"	N.P.T.	W.F.	C.S.	STD.	STD.	-	-
G	6"	N.P.T.	H.CPL.	C.S.	STD.	STD.	-	-

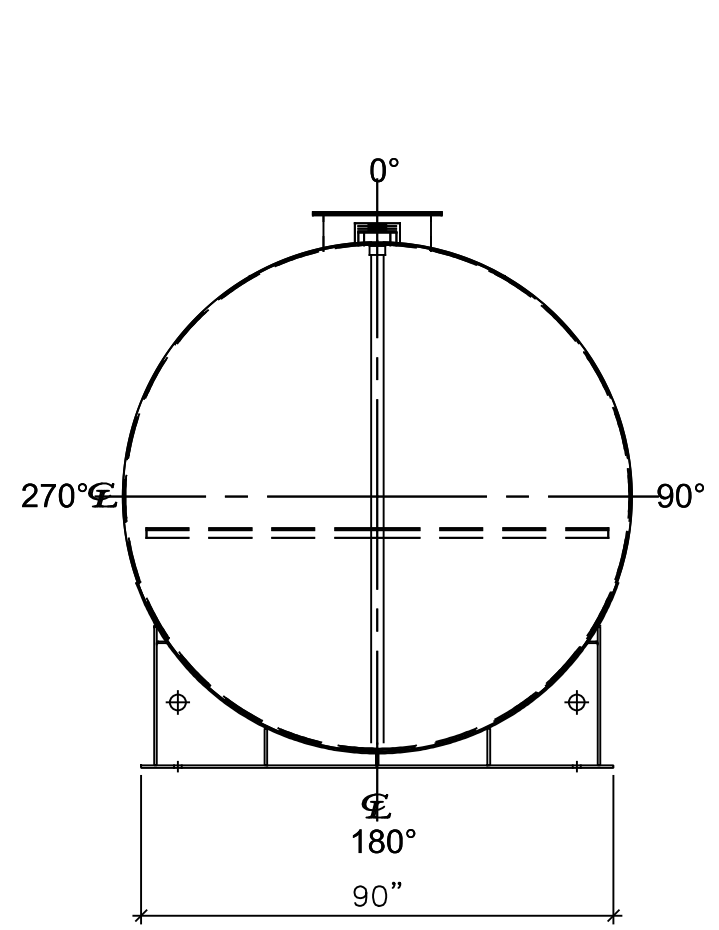

LEFT SIDE

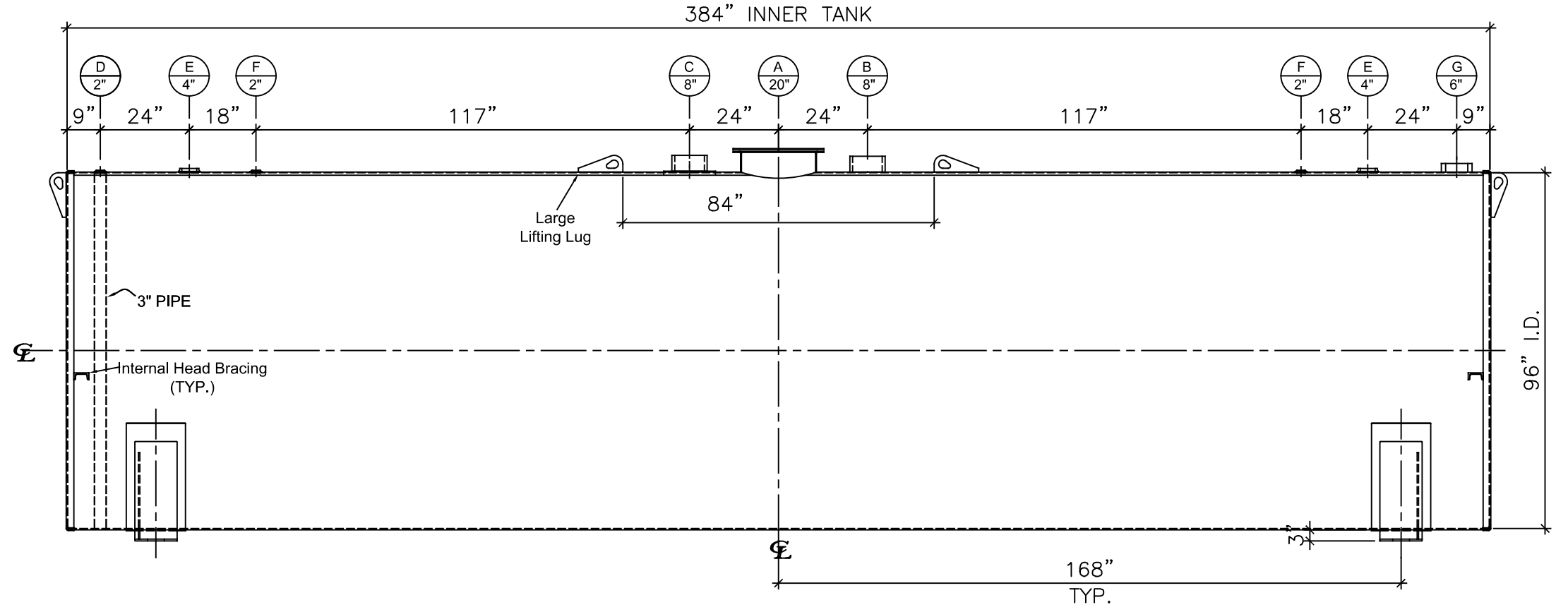

FRONT VIEW

- NOTES:**
- A. Material: H.R. Carbon Steel.
 - B. Design Pressure: Atmospheric.
 - C. Design Temperature: Ambient.
 - D. Built & labeled per U.L. #142 & SwRI 97-04 specifications.
 - E. Exterior: Blast & apply one shop coat WHITE enamel.
 - F. All fittings to be protected for shipment.
 - G. Customer to verify nozzle sizes, locations and quantities.
 - H. Saddles/skids may require shimming or grouting during installation.

APPROVAL FOR CONSTRUCTION
SCHEDULE A - MASTER TERMS &
CONDITION OF SALE*

APPROVED AS DRAWN.

APPROVED WITH NOTED CHANGES.
CONSTRUCTION WILL BE SCHEDULED
WHEN SIGNED DRAWING AND
CONFIRMED ORDER ARE RECEIVED.

SIGNATURE: _____

DATE: _____

*All pages of this Schedule A are incorporated by reference and are a part of the additional terms of the Master Terms & Conditions of Sale. www.newberrytanks.com/masterterms.pdf

SALES ORDER:

Newberry Tanks
New Thinking

Phone: 870-735-4473

WEIGHT (LBS): 17000

All units inches unless stated otherwise

DESCRIPTION:
12,000 Gallon 96" I.D. x 32'-0" O.A.L. Double Wall Flameshield Tank

CUSTOMER: _____ P.O.# _____

DATE: 3/8/2023 SCALE: _____ DWG.# NB12000FSD096250 DRAWN BY: AJC

SHEET 1 OF 1